



HEATING ELEMENTS

Heating elements are often produced to customer-specific requirements.

Heating elements are used for applications such as ovens, cookers and griddles and for warming up tools and machinery. These heating elements are very flexible and can be bent to suit the application.

JEVI's compressed heating elements comprise three components:

- a special alloy resistance wire which is centered in the tube (resistance wire can be CrNi or DSD)
- magnesium oxide for electrical insulation
- steel tube cap, material depending on application

TUBE TYPES

JEVI has a broad range of steel types which make it possible to supply products for more or less all applications.

The table on page 2 shows the stocked steel types, maximum length, temperature range and terminal options.

Page 7-9 describe the standard tubes in the material grades we have chosen to have on stock, while other material grades can of course always be delivered on request.

COLD ZONE

The cold zones at the tube ends may vary from 35mm up to 1200mm depending on the choice of terminal and tube type.

SEALING

The heating element is sealed to prevent the magnesium oxide from absorbing moisture and thereby causing a transition point in the heating element. Two types of sealant are used, depending on how high temperature the seal may be subject to.

- silicone: max. 180°C
- polyurethane: max. 120°C

Silicone can only be used in continuous operation in which the heating element is not exposed to moisture, as silicone is not diffusion-proof so moisture transfer is possible. Polyurethane is diffusion-proof and bonds well to metal.

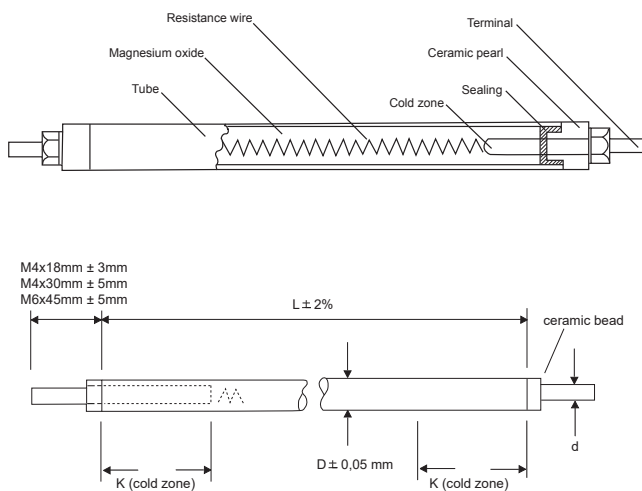

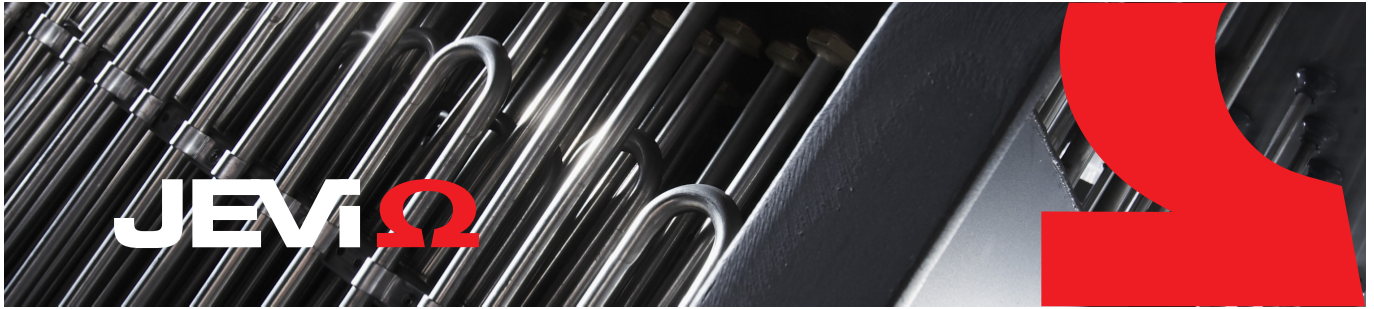

TUBE TYPES

Material	Dimension	Max. surface temperature	Max. tube length	Ø2.5 pin	Ø3.5 pin	M4 steel	M4 stainless steel	M6 stainless steel
Copper	Ø6.25	117°C	7140	x				
Copper	Ø8.50	117°C	6960		x	x	x	
Copper	Ø10.2	117°C	7800		x	x	x	
AISI 304	Ø6.25	750°C	6762	x				
AISI 304	Ø8.50	750°C	6780		x	x	x	
AISI 321	Ø8.50	750°C	6744		x	x	x	
AISI 321	Ø10.2	750°C	7590		x	x	x	
AISI 309	Ø8.50	820°C	6750		x	x	x	
AISI 309	Ø10.2	820°C	7632		x	x	x	
AISI 316L	Ø6.25	700°C	6858	x				
AISI 316L	Ø8.50	700°C	6768		x	x	x	
AISI 316L	Ø10.2	700°C	7650		x	x	x	
AISI 316L	Ø12.7	700°C	7014					x
AISI 316TI	Ø8,50	700°C	6810		x	x	x	
Inconell 600	Ø8.50	980°C	6780		x	x	x	
Inconell 600	Ø12.7	980°C	6990					x
Incoloy 800	Ø6.25	800°C	6840	x				
Incoloy 800	Ø8.50	800°C	6774		x	x	x	
Incoloy 800	Ø10.2	800°C	7710		x	x	x	
Incoloy 800	Ø12.7	800°C	6990					x
Incoloy 825	Ø6.25	750°C	6840	x				
Incoloy 825	Ø8.50	750°C	6792		x	x	x	
Incoloy 825	Ø12.7	750°C	7038					x
SMO 254	Ø8.50	400°C	6750		x	x	x	
Titanium	Ø8.50	650°C	6792		x	x	x	
Titanium	Ø12.7	650°C	7110					x



APPLICATIONS

Of course, when choosing a tube cap material, the medium to be heated has a significant part to play. The surface load, W/cm², is another factor. If the surface load is too high, the heating element will overheat and burn. In the case of certain medium where the heat transmission is particularly high, a significantly higher surface load than in air can be accepted, just as the media may make specific demands of the tube cap material on account of corrosion problems.

Likewise the media may demand a particularly low surface temperature due to – for example – a risk of fire or coating problems. The issue of corrosion can often be resolved by contacting a supplier of chemicals.

This guideline table specifies the recommended maximum surface load in W/cm² for various heating purposes in connection with the most suitable tube cap materials.

Heating materials			Tube cap materials								
Liquid media	Max. W/cm ²	CU	AISI 304	AISI 309	AISI 316	AISI 321	INC 600	INC 800	INC 825	SMO 254	Titanium
Water, stagnant	6-10	x							x	x	x
Water, moving	10-15	x							x	x	x
Alkaline bath	4-6								x	x	x
Water-dissolved acids and salts	1-2								x	x	x
Phosphating bath	2-4										
Ammonia and ammonium chloride bath	2-3								x	x	x
Oil, thin	1-3		x		x				x	x	x
Oil, thick	1-1½		x		x						
Wax and lacquers	0.5		x		x						
Gaseous media											
Air, stationary	1-3		x	x	x	x	x	x			
Air, moving	5		x	x	x	x	x	x			
Steam 100°C	2-4	x				x		x	x	x	
Steam 250°C	1-3					x		x	x	x	
Steam 500°C	1-3							x	x		
Flue gas 300°C	1-3				x	x	x	x	x	x	
Solid media (e.g. steel plate)											
Without regulation	1-½		x	x	x	x	x	x	x		
Embedded in metal	4-6		x	x	x	x	x	x	x		
With regulation	8-10		x	x	x	x	x	x	x		
Laid in track	3-6		x	x	x	x	x	x	x		



BENDING SKETCHES

	1	2	3	4
Q				
R				
S				
T				
U				
V			<p>There are many different ways of bending heating elements. Take a look at the table and find the bend drawing that suits your requirements – or send us a drawing of your own!</p>	



CONNECTIONS

The illustrations show typical end pieces used for heating elements and electric heater cartridges. There are lots of other options available, too, so please contact our technical sales team for more information.

M4 threaded bolt on Ø8.5 and Ø10.2 tubes.
M6 threaded bolt on Ø12.7 tube only.



Double spade, 90° angle.



Single spade 6.3 mm.

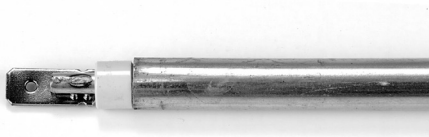

Fitted with an insulated flex or stranded wire.
High-temperature flex for up to 400°C is stocked.



Single spade with 45° or 90° angle bend.



End piece with welded cable and shrink flex.



Double spade, straight.



Fully cast end piece with polyurethane for outstanding seal.





FLANGES AND NIPPLES

Heating elements soldered or welded with brass or stainless steel nipples. The following are stocked:

Brass nipples: ½", ¾", 1", 1¼", 1½", 2", 2½" and 3"

Stainless steel nipples: ½", ¾", 1", 1½" and 2½".



UF40 flange for household appliances. Can be used for one heating element only.

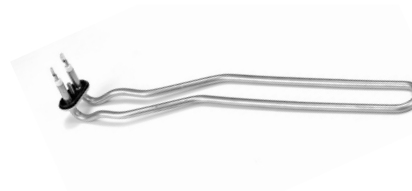

Immersion heater with oval galvanised or stainless box , IP55 with PG 13.5. 1½" and 2" are stocked as standard.

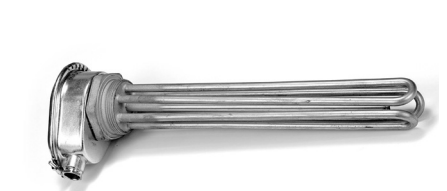

UF70 flange for household appliances. Can be used for one or two heating elements.

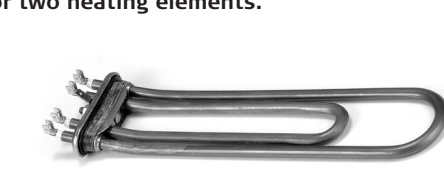

Immersion heater with square box. Thermostat and thermofuse fitting optional depending on task and temperature.

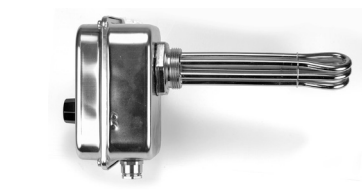

Junction boxes for immersion heaters and heating elements. These can be fitted with thermostats and thermofuses depending on type.



Heating elements terminated with nipples for fitting in tanks or reservoirs. Can be fitted with an oval or square box. Nipples are stocked in: M10, M12, M14 and M16 sizes, made of brass and stainless steel. M14 made of galvanized steel is also stocked.



Special flanges for immersion heaters and heating elements. The various flanges can be soldered, welded or clamped onto the heating elements.





STAINLESS STEEL, AISI 304

To ensure fast delivery, Jevi stocks many standard tubes of all sizes, with various loads. All standard tubes of Ø8.5mm and Ø10.2mm come with M4 treaded bolt. Standard tubes of Ø6.25mm come with a Ø2.5mm pin (flat). It is possible to weld a spade or wire onto a flat pin.

AISI 304 is used widely for duct heater in ventilation and air conditioning systems, for ovens, cookers and griddles, warming up tools and machinery, fan heaters and oil heater cartridges. AISI 304 is not suitable for water, and can be used only to a very limited extent for chemicals. The surface load must be very low for use in air and oil. The surface load may be increased in the case of contact heating.

STANDARD PROGRAMME

Item no.	Length mm	Voltage	Power	Surface load
Type Ø6.25mm, AISI 304, cold zone 55mm				
22800080	350	230V	225W	4.8 W/cm ²
22800098	500	230V	350W	4.6 W/cm ²
22800106	600	230V	500W	5.2 W/cm ²
22800114	850	230V	750W	5.2 W/cm ²
22800122	1100	230V	1000W	5.1 W/cm ²
22800130	1300	230V	1200W	5.1 W/cm ²
22800148	1600	230V	1500W	5.1 W/cm ²
22800155	2100	230V	1000W	2.6 W/cm ²
22800163	2100	230V	1500W	3.8 W/cm ²
22800171	2100	230V	2000W	5.1 W/cm ²
22800254	600	400V	500W	5.2 W/cm ²
22800262	850	400V	750W	5.2 W/cm ²
22800270	1100	400V	1000W	5.1 W/cm ²
22800288	1300	400V	1200W	5.1 W/cm ²
22800296	1600	400V	1500W	5.1 W/cm ²
22800304	2100	400V	1000W	2.6 W/cm ²
22800312	2100	400V	2000W	5.1 W/cm ²
22800320	2500	400V	2500W	5.3 W/cm ²

Item no.	Length mm	Voltage	Power	Surface load
Type Ø8.5mm, AISI 304, cold zone 90mm				
23801202	700	400V	500W	3.6 W/cm ²
23801210	1000	400V	750W	3.4 W/cm ²
23801228	1350	400V	1000W	3.2 W/cm ²
23801236	1950	400V	1500W	3.2 W/cm ²
23801244	2600	400V	2000W	3.1 W/cm ²
23801251	3450	400V	2700W	3.1 W/cm ²
23801269	700	400V	1000W	7.2 W/cm ²
23801277	1000	400V	1500W	6.8 W/cm ²
23801285	1350	400V	2000W	6.4 W/cm ²
23801293	1950	400V	3000W	6.3 W/cm ²
23801301	2600	400V	4000W	6.2 W/cm ²
23801319	3450	400V	5400W	6.2 W/cm ²
23800964	500	230V	150W	1.8 W/cm ²
23800972	500	230V	250W	2.9 W/cm ²
23800980	650	400V	500W	4.0 W/cm ²
23800998	650	400V	1000W	8.0 W/cm ²
23801004	900	400V	1500W	7.8 W/cm ²
23801012	1200	400V	2100W	7.7 W/cm ²
23801020	1500	400V	2700W	7.7 W/cm ²
23801038	1800	400V	3300W	7.6 W/cm ²
23801046	2100	230V	1300W	2.5 W/cm ²
23801053	2400	230V	1500W	2.5 W/cm ²
23801061	2700	230V	1700W	2.5 W/cm ²
23801087	3350	230V	2100W	2.5 W/cm ²
23801103	3900	230V	2500W	2.5 W/cm ²
23801525	750	400V	700W	4.6 W/cm ²
23801541	950	400V	1000W	4.9 W/cm ²
23801566	1350	400V	1500W	4.8 W/cm ²
23801582	1750	400V	2000W	4.8 W/cm ²
23801608	2200	400V	2500W	4.6 W/cm ²
23801624	2600	400V	3000W	4.6 W/cm ²
23801657	3450	400V	4000W	4.6 W/cm ²



STAINLESS STEEL, AISI 316L & 321

AISI 316L is used primarily for air heating in duct heater, particularly for offshore applications, oil installation and in other humid environments.

AISI 316L can also be used to a limited extent against some acids/bases and aggressive gases.

AISI 321 can also be used to a limited extent against aggressive gases, low temperature water vapor and flue gas.

STANDARD PROGRAMME

Item no.	Length mm	Voltage	Power	Surface load
Type Ø8.5mm, AISI 316L, cold zone 90mm				
23802101	500	230V	1000W	11.7 W/cm ²
23802119	700	230V	1500W	10.8 W/cm ²
23802127	900	230V	2000W	10.4 W/cm ²
23802135	1300	230V	3000W	10.0 W/cm ²
23802143	500	400V	1000W	11.7 W/cm ²
23802150	700	400V	1500W	10.8 W/cm ²
23802168	900	400V	2000W	10.4 W/cm ²
23802176	1300	400V	3000W	10.0 W/cm ²
23802184	1700	400V	4000W	9.8 W/cm ²
23802192	1000	230V	1000W	4.6 W/cm ²
23802200	1350	230V	1500W	4.8 W/cm ²
23802218	1700	230V	2000W	4.9 W/cm ²
23802226	1000	400V	1000W	4.6 W/cm ²
23802234	1350	400V	1500W	4.8 W/cm ²
23802242	1700	400V	2000W	4.9 W/cm ²
23802259	3000	400V	3500W	4.6 W/cm ²

STANDARD PROGRAMME

Item no.	Length mm	Voltage	Power	Surface load
Type Ø10.2mm, AISI 321, cold zone 90mm				
24800104	1800	400V	2500W	4.8 W/cm ²
24800112	2100	400V	3000W	4.8 W/cm ²
24800120	2500	400V	3500W	4.7 W/cm ²



CORROSION AND ACID RESISTANT, INCOLOY 825

Incoloy 825 is used wherever heating elements are required which are able to withstand aggressive media, but it can also be used for heating water which contains a lot of minerals and lime.

Incoloy 825 is a high alloy steel with a molybdenum content higher than the AISI types, making it suitable for aggressive media. Incoloy 825 is replacing the AISI steels to an increasing extent in many areas.

STANDARD PROGRAMME

Item no.	Length mm	Voltage	Power	Surface load
Type Ø8.5mm, Incoloy 825, cold zone 90mm				
23804008	600	230V	1000W	8.9 W/cm ²
23804016	850	400V	1500W	8.4 W/cm ²
23804024	1100	400V	2000W	8.1 W/cm ²
23804040	1550	400V	3000W	8.2 W/cm ²
23804032	2000	400V	4000W	8.2 W/cm ²
23804057	3000	230V	2000W	2.7 W/cm ²

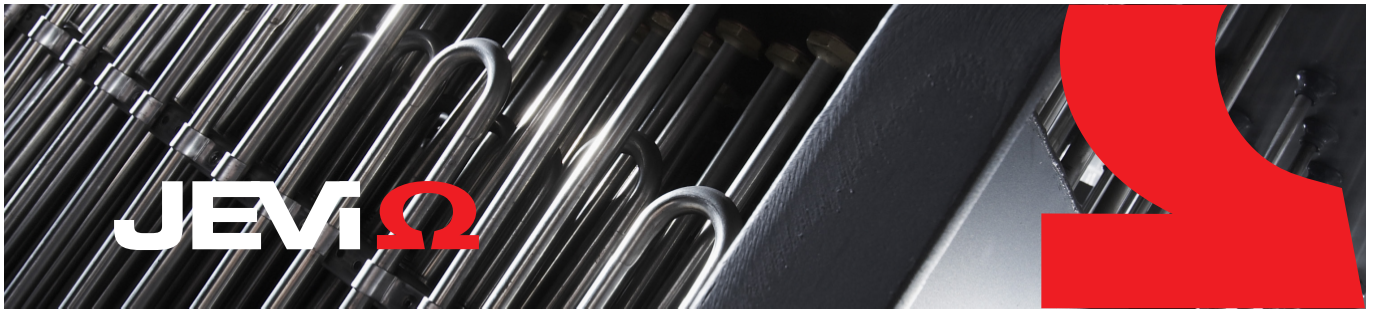

DIMENSIONING

Diagrams/curves are used to indicate the maximum permitted surface load (W/cm^2) as a function of the operating/ambient temperature. These curves act merely as a guideline as the heat passing between the elements will have a part to play. If the heating elements are used in a duct heater, the length of this will also have an influence.

Example 1 (see the diagram below)

We wish to find out what maximum permitted surface load is applicable to the heating element, working on the basis of the following information:

- the duct heater has an input temperature of $20^\circ C$
- the air speed is 2 m/sec.
- AISI 304 is used (indicated to be able to withstand $700-800^\circ C$)
- a maximum permitted surface temperature of $500^\circ C$ is selected for safety reasons

Which is the correct surface load for this element?

We select the curve $20^\circ C$ 2 m/sec and follow it down to $500^\circ C$. A maximum permitted surface load of $3.5 W/cm^2$ can be seen. If this is too low, it is possible to select a faster airflow of 5 m/sec, for example, which would give a value of $5.8 W/cm^2$, or else less stringent requirements for a safety temperature of $500^\circ C$ could be selected.

Example 2 (see the diagram below)

What would the maximum permitted surface load be if we have an AISI 316 heating element and the following operating conditions are prevalent?

- operating temperature of $350^\circ C$
- the heating element is located in stationary air, 0 m/sec.

We select the curve $350^\circ C$ 0 m/sec and follow it until we see AISI 316. We can see a maximum permitted surface load of $4 W/cm^2$. If a different type of steel is selected, such as Incoloy 800, the surface load increases to $6.4 W/cm^2$.

