



EN
Installation, operation and maintenance manual
For installation in non-hazardous areas

**NON-PRESSURIZED
WATER-COOLED BRAKING RESISTOR
WCBR**

All rights reserved. Reproduction or issue to third parties of this manual or part of it in any form is not permitted without prior written authorisation of the proprietor



EN

Safety information	3
Disclaimer	4
1.0 Introduction.....	6
2.0 Description of product	8
2.1 Reference documents	8
2.2 Marking plate.....	8
2.3 Instrumentation.....	9
2.3.1 Safety temperature limiter	9
2.3.2 Outlet temperature sensor with transmitter.....	9
2.3.3 Level switch and/or level transmitter	9
3.0 Packing	10
3.1 Choice of the Packing Type.....	10
3.2 Wood treatment.....	10
3.3 Pallets.....	10
3.4 Handling	10
3.5 Centre of gravity	10
3.6 Labelling and tagging of equipment / Identification	10
3.7 Shipping marks / labelling	10
4.0 Transportation	11
4.1 Squared vessels.....	11
4.2 Rectangular vessels	12
5.0 Storage and preservation	13
5.1 Preservation during the transportation and pre-installation period	13
5.2 Preservation during the installation/construction period	13
5.3 Suggestion for preservation specification & record:	15
6.0 Installation instructions	16
6.1 Water quality	16
6.2 Mechanical installation	16
6.2.1 Goose neck pipe	17
6.3 Recommended tightening torque according to thread size	18
6.4 Electrical installation.....	18
7.0 Start up.....	20
7.1 Start-up	20
7.2 How to switch off the WCBR	21
7.3 Spare parts.....	21
8.0 Operating instructions	22
8.1 Operating temperature	22
9.0 Maintenance instructions.....	23
9.1 Overview of the inside of the WCBR	23
9.2 Cathodic protection of the vessel	23
9.3 Maintenance instructions 6-months interval	25
9.4 Maintenance instructions 1-year interval	26
9.5 Maintenance instructions 3-year interval	27
9.6 Instruction for anode replacement (only for seawater)	29
9.7 Disassembly of WCBR insert	29
9.8 Recommended maintenance and service plan.....	30

10.0 Trouble shooting.....	32
11.0 Disposal instructions	33

Safety information

To secure your personal safety, as well as prevent damages to property, this manual contains notices you have to observe. The notices refer to your personal safety:

 DANGER	Indicates that death or severe personal injury will result if proper precautions are not taken.
 WARNING	With a safety alert symbol, indicates that minor personal injury can result if proper precautions are not taken.
CAUTION	Without a safety alert symbol, indicates that property damage can result if proper precautions are not taken.
NOTICE	Indicates that an unintended result or situation can occur if the corresponding information is not considered.

If more than one degree of danger is present, the warning notice representing the highest degree of danger will be used. A notice warning of injury to persons with a safety symbol may also include a warning relating to property damage.

Qualified Personnel

Only personnel qualified for the specific task in accordance with the relevant documentation for the specific task, in particular its warning notices and safety instructions may operate the product described in this documentation. Qualified personnel are those who, based on their training and experience, can identify risks and avoid potential hazards when working with these products/systems.

Proper use of JEVI products

 WARNING	Proper transport, storage, installation, assembly, commissioning, operation and maintenance is required to ensure that the product operates safely and without any problems. The permissible ambient conditions must be adhered to. Observe the information in the relevant documentation.
--	--

Disclaimer

JEVI A/S assumes no responsibility for any additions placed by the customer that can inflict our product. Additions or alterations implemented by the customer are not covered by our warranty.

IMPORTANT: These instructions should be read thoroughly before installation and operation. All warnings and precautions should be observed for both personal safety and for proper equipment performance and longevity. Failure to follow these instructions could result in equipment failure and/or serious injury to personnel.

Braking resistors operate under high voltages when connected to the inverter and are lethal when not handled with care. It is very important to ensure that the inverter is not energized, when installing or servicing this unit. Always allow adequate time after removing inverter power before touching any components.

This IOM is a standard document and is not project specific.

The English IOM is JEVI's standard version

List of abbreviations	
ACBR	Air Cooled Braking Resistor
CoG	Centre of Gravity
EF	Electrical Duct heater
GA	General Arrangement (Drawing)
HVAC	Heating, Ventilation, Air Conditioning
IOM	Installation, Operating and Maintenance Manual
JB	Junction Box
VLE	Fan heater with integrated controls for temperature control
VLEx	Fan heater for explosive areas
WCBR	Water Cooled Braking Resistor
TSH	Temperature Switch High
TSHH	Temperature Switch High High

1.0 Introduction

This manual is valid for the following models of water-cooled Braking Resistors (WCBR), both including sea water-cooled and fresh water-cooled systems.

The purpose of this document is to introduce the reader to installation, operation and maintenance of non-pressurized WCBR and most importantly to introduce general safety precautions, which are not necessarily related to any specific part or procedure and do not necessarily appear elsewhere in the publication.

These precautions must be thoroughly understood and applied to in all phases of operation and maintenance.

Descriptions in this manual are generic and not project specific. Pictures may show other equipment and options than in the actual project.

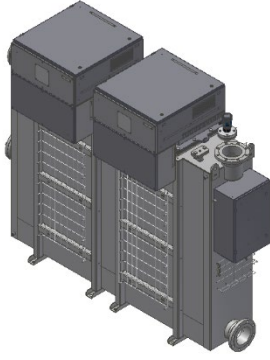
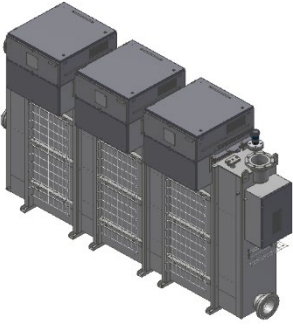
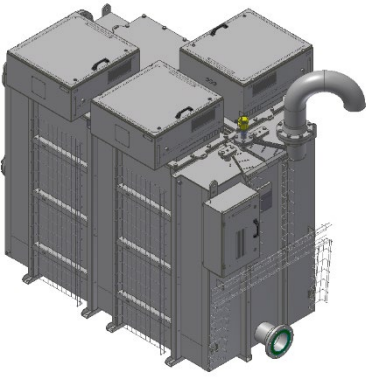
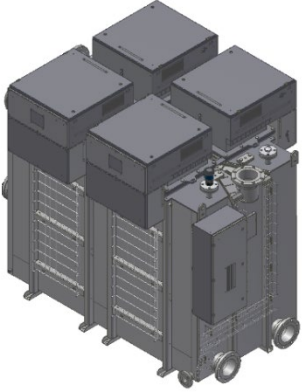
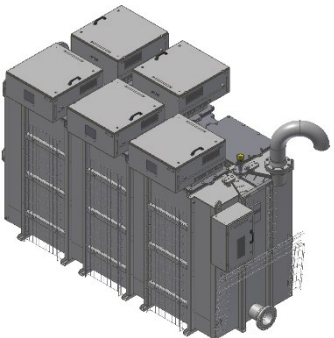
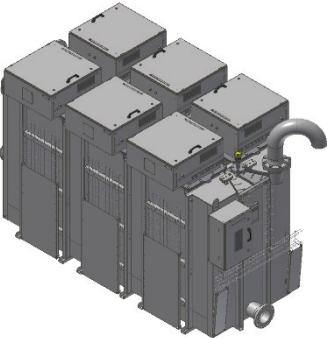
	
Two inserts – rectangular vessel	Three inserts – rectangular vessel
	
Three inserts – squared vessel	Four inserts – squared vessel
	
Five inserts – rectangular vessel	Six inserts – rectangular vessel

2.0 Description of product

A WCBR acts as a load bank in motion systems where a motor is controlled by a drive. When decelerating, the motor becomes a generator where it produces electrical energy. When braking, energy surplus is being dissipated as heat by a WCBR.

2.1 Reference documents

The following documents are referenced in the below text. It is advised to have the documents available when reading this document.

Document description
GA-Drawing
Electrical Wiring Diagram
WCBR Data Sheet
WCBR FAT record (if any)
WCBR Spare Part List

2.2 Marking plate



Please refer to part number at any enquiry

Example of marking plate

2.3 Instrumentation

2.3.1 Safety temperature limiter

If installed, the TSHH safety thermostat is mounted on the heating element and the temperature set is 95°C. If the TSHH cuts out, the thermostat must be reset in order to restart the system.

If installed the TSH is mounted in the insert and the temperature is set according to electrical wiring diagram. If the water temperature rises above set temperature, the heating elements cut off until the temperature is below the set temperature. The TSH is sealed at the set temperature from JEVI.

If installed the PT-100 sensor with transmitter is mounted on the outlet side of the vessel or in a sensor pocket inside the vessel. The signal output range is 4-20 mA, covering a temperature range according to electrical wiring diagram/test record.

2.3.2 Outlet temperature sensor with transmitter

If installed, the PT-100 sensor with transmitter is mounted on the outlet side of the vessel or in a sensor pocket inside the vessel. The signal output range is 4-20 mA, covering a temperature range according to electrical wiring diagram/test record.

2.3.3 Level switch and/or level transmitter

If installed, the level switch and/or level transmitter is mounted in the top of the vessel. The functionality of the level switch/level transmitter is tested at final inspection at JEVI.

3.0 Packing

All packing is in accordance with the specific requirements of the individual purchase order or contract as well as with the regulations of the country of destination.

3.1 Choice of the Packing Type

The choice of the packing type and the requirement of particular protections depend on characteristics of the equipment and material to be packed, its handling requirements and kind of transport chosen.

The packing provides both mechanical and environmental protection.

3.2 Wood treatment

All solid wood, used for packing (including wooden pallets) is heat or fumigation treated according to the international standard ISPM 15 (IPPC), latest revision.

As these rules are not the same for all countries, the procedure must meet the demands of a country of final destination.

3.3 Pallets

Equipment is packed on pallets that provide adequate load support during transportation and storage. The pallets have a dynamic load capacity, enough to carry the mass loaded on the pallet.

Where feasible the top surface of the pallet must be flat.

The pallet must be tight on all sides with steel or synthetic straps on each side.

Bolts, clamps, supporting beams, etc. will properly fix all equipment and materials.

Fragile, easily damageable and loose parts will be pertaining to the equipment securely and properly packed in a separate case.

3.4 Handling

Under no circumstances may the equipment itself be used as a platform for gaining access to installation and construction areas above. If such access is required, suitable scaffolding must be established. The equipment may not be used as a support.

3.5 Centre of gravity

If required, large and heavy equipment are marked with Centre of Gravity (COG).

3.6 Labelling and tagging of equipment / Identification

If no specific identification is required, (see the Purchase Order for the technical specifications) the labelling is in accordance with JEVI standard.

On demand the identification label is in accordance with the final packing list/delivery note.

3.7 Shipping marks / labelling

All packages are marked or labelled in accordance with the data shown in the packing list/delivery note.

4.0 Transportation

The product is packed according to agreement, with indication of CoG if required by customer.

The product is packed on pallets. The packing is easily moved either by forklift or by use of crane, handled by authorised personnel.

For lifting lugs, see GA

For weight, see GA or rating plate

For COG, see GA

CAUTION	Resistor elements must <u>NOT</u> be used for lifting, this causes damage to the elements
CAUTION	Do <u>NOT</u> use the lifting eye on main flange of the insert
 WARNING	Never lift a unit filled with water.

4.1 Squared vessels

For lifting use the four (4) lifting eyes on top of the vessel. Lifting yoke(s) must be used when lifting the rack.

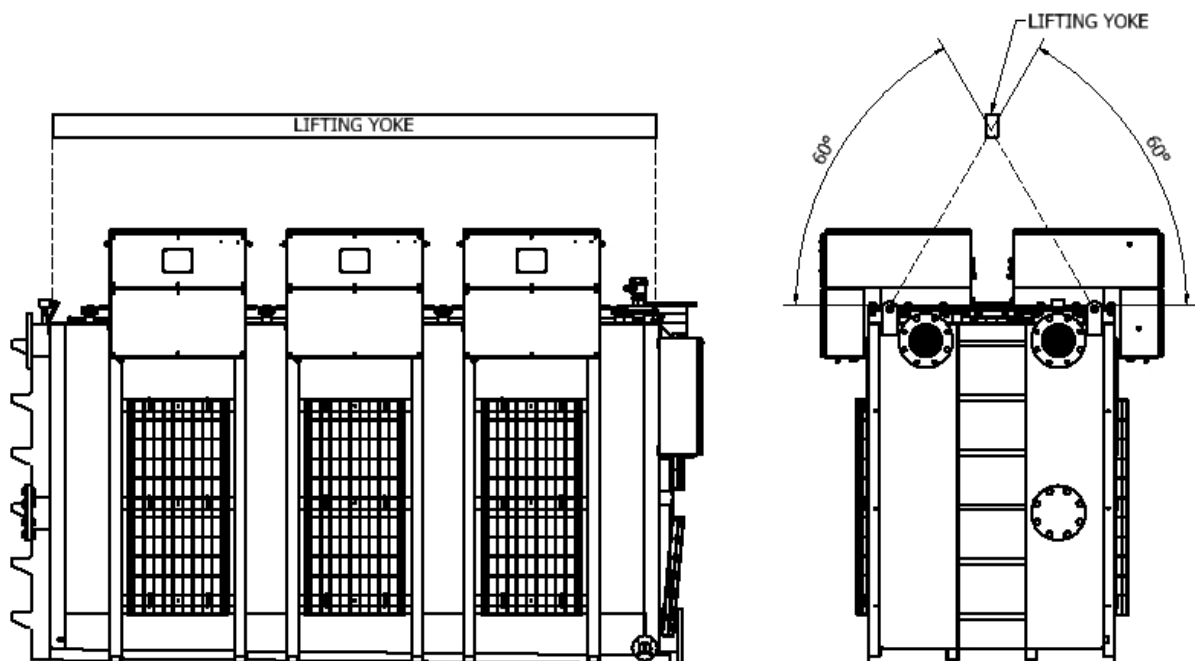

4.2 Rectangular vessels

For lifting use the four (4) lifting eyes on top of the vessel. Lifting yoke(s) must be used when lifting the rack.

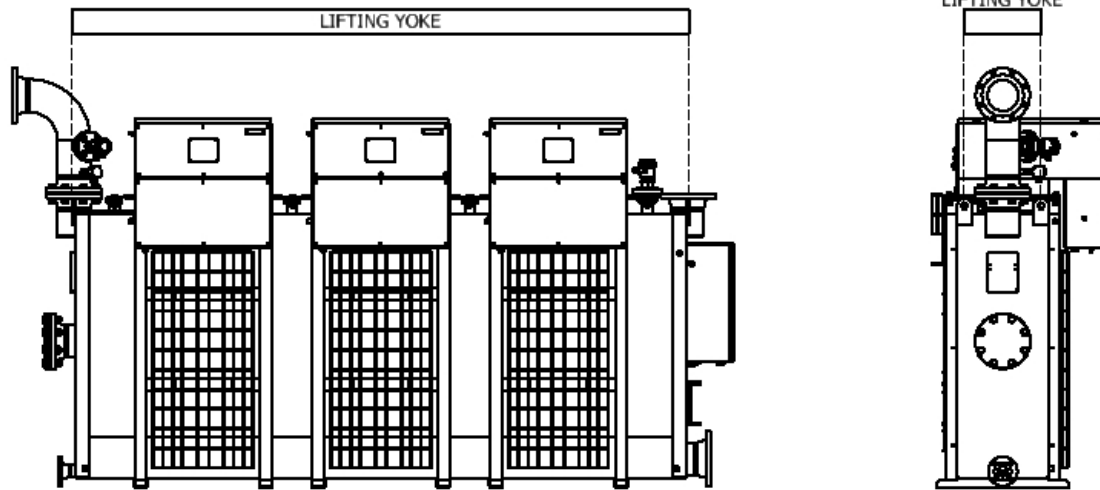

5.0 Storage and preservation

The purpose of this chapter is to specify how to handle and preserve a product from the day of shipment until the equipment is installed and commissioned.

The following conditions shall be observed for the installation/construction period.

CAUTION	During storage, prior to installation the unit must be stored dry with a relative humidity <60 %, temperature >15°C.
CAUTION	Replace desiccant bag in junction boxes and enclosures (if any) every 6 months. Keep a log of the replacements as documentation.
CAUTION	The anti-condensation heater, if any, must always be powered up and connected.

5.1 Preservation during the transportation and pre-installation period

The packaging provides both mechanical and environmental protection. If the equipment is intended for service in an outdoor environment, to avoid any risk of harmful metallic dust during storage it is protected with enveloping plastic foil. All openings such as cable entry holes are adequately sealed.

Packages must not be opened, or their integrity disturbed during the transport. Packing may only be opened when the equipment has been taken from storage and has been transported to its intended location of installation, or to connect the anti-condensation heater, after which the packing must be resealed. Storage preservation measures are immediately invalidated as soon as the packaging is disturbed.

One shall inspect packages on receipt at the storage warehouse and at regular monthly intervals during the storage period regarding external damages. Any visible damage that may have a consequence to the condition of the contents or integrity of the preservation must be immediately documented and reported. In case of such an event, the supplier must be contacted immediately for advice.

5.2 Preservation during the installation/construction period

The product must be unpacked only when the equipment is to be installed, or to connect the anti-condensation heater. It is recommended to maintain the integrity of the packaging during transport from the storage warehouse to the installation site. Inspect the equipment within each package for damage and condition as soon as the package is opened. Report and document any damage immediately. In case of such an event, the supplier must be contacted immediately for advice.

Installation and handling of the equipment once unpacked must be performed in accordance with the relevant elements of the documentation for the equipment delivered. Damages caused by bad workmanship or failure to adhere to the installation instructions are not covered by the equipment warranty.

If the equipment is installed in an area where ongoing construction work of a nature that causes airborne pollution or other adverse conditions take place, the equipment must be suitably protected. Under no circumstances can the equipment be placed in the vicinity of any activity, which involves grinding, welding, painting, fireproofing, spraying, etc. without taking necessary precautions to protect it.

When cable termination is completed, a fresh desiccant bag must be placed in the enclosure. The desiccant bag must be replaced every 6 month or until commissioning has been initiated.

All openings such as cable entry holes must be adequately sealed until the interfacing cables or pipes are installed.

During installation, always keep the equipment in a clean condition. Remove debris from cable installation activities at once. Take precautions to avoid any small pieces of a conductive nature from being left in the termination enclosures.

Under no circumstances may the equipment itself be used as a platform for gaining access to installation and construction areas above. If such access is required, suitable scaffolding must be established, as the equipment may not be used as a support.

During installation the equipment must be thoroughly inspected at regular weekly intervals with regards to external damages, cleanliness and internal condition. Report and document immediately if any visible damage or adverse condition occurs. In case of such an event, the supplier must be contacted immediately for advice.

On completion of the installation work the condition of the equipment must be inspected. Report and document any damage immediately if any visible damage. In case of such an event, the supplier must be contacted immediately for advice.

CAUTION	It is extremely important that no debris enters the vessel as this may lead to a blockage of the return or overflow pipes.
----------------	--

5.3 Suggestion for preservation specification & record:

PRESERVATION SPECIFICATION & RECORD									
Record No.:		Tag No.:		Description:					Record page 1 of 1
Activity No.:	Intervals (Months)	Description of Preservation Activity	Recommended Preservative	Initial Preservation	Date/Sign Preserved (2)	Date/Sign Preserved (3)	Date/Sign Preserved (4)	Date/Sign Preserved (5)	
1	1	Check that protection structure is undamaged.							
2	6	The desiccant bag inside the Junction boxes replaced.							
3	1	Check the storage conditions. Relative humidity < = 60 %, temp. > = 15°C							
4	12	If stored for more than one year from packing date, then the supplier must be contacted for advice regarding renewal of the desiccant bag.							
5	12	Check the paintwork.							
6	12	Check that there are no visual damages to the equipment.							
7	12	Verify that the general condition of the equipment is satisfactory.							
8	12	All openings such as cable entry holes are adequately sealed. Junction Boxes as well.							
9	12	All loose items/removed parts preserved, stored and marked.							
10	6	Verify no water leakages, condensation or moisture where applicable.							
11	6	The Anti-condensation heater in the equipment must be powered up and connected at all times.							
Comments:									
Performed by: Date/Sign:				Accepted by: Date/Sign:					

Note: These procedures are considered normal maintenance and are performed at the owner's expense.

* Depending on the environment, inspection frequency can vary.

6.0 Installation instructions

The responsible for the installation must ensure that his employees are fully trained and supervised in the proper installation and working procedures to ensure their safety.

Before unpacking the braking WCBR ensure that all crates or packaging are in good condition and undamaged. Any damage must be reported to the site manager and subsequently to JEVI A/S and the shipping company.

After removing the wooden box, check all items for damage, and if any, report to the site manager and subsequently to JEVI A/S.

Cover the WCBR with a blanket or similar until all metal work has been completed on the nearby installations. Not doing so might lead to local corrosion in the stainless surfaces.

6.1 Water quality

Sea Water

The user must ensure that any cooling water used for testing and/or when unit is in service operation, is free of fluoride salts and hydrofluoric acid as these chemicals can damage the titanium elements. Maximum allowed particle size in the cooling water is 1 mm. If the resistors tank has been emptied and it is planned to stop operations for an extensive period, the tank must be cleaned with fresh water and fully drained.

Fresh Water

The user must ensure that any cooling water used for testing and/or when unit is in service operation, is free from chlorides and with a PH-value between 6 and 8. De-mineralized water is not to be used as cooling water due to the risk of corrosion. If resistors tank has been emptied and it is planned to stop operations for an extensive period, the tank must be cleaned with fresh water and fully drained.

6.2 Mechanical installation

Reference is made to the GA-Drawing for the WCBR.

For lifting instructions, please see section Transportation

- Mount the WCBR to the deck with bolts. The bolts are not supplied with the WCBR. The yard must ensure that correct torque is applied to the type of bolts chosen.
- Remove the protective plates from the inlet and outlet.
- Connect the cooling water system to the flanges according to the GA-Drawing. Make sure that the forces from the piping system (e.g. temperature expansion and weight) cannot damage the vessel.

CAUTION	Note that the inlet and outlet are not designed to obtain forces from the piping system. It is therefore recommended to use flexible joints on inlet and outlet!
----------------	---

- Connect the overflow piping to the top flange with the supplied bolts, nuts and gasket. For applied torque please see section [6.3 Recommended tightening torque according to thread size](#)
- Fresh-water model with flow transmitter only: When the system is filled with water, the pipes from the diaphragm to the flow transmitter must be loosened to make sure there is only water inside the pipes.

6.2.1 Goose neck pipe

The goose neck is a vent system which is an integrated part of the non-pressurized systems. During operation a non-operation mode air from the piping system can accumulate in the tank.

Without the goose neck vent, the pressure inside the tank will exceed the maximum pressure and be followed up with eventually damaging the tank. The purpose of the goose neck is to always remove air from the non-pressurized tank. The goose neck allows a non-pressurized system to breathe and eliminate pressure to build up.

If not installed directly on the tank flange with attached gasket, nuts and bolts but on a combination of pipe-manifold it must be at the highest point. Any pipe replacing the goose neck must as minimum be the same size as the goose neck 6", and the flange must have gasket (see WCBR Spare Part List).

JEVI recommend flanges and pipes in material AISI316 or similar. Due to the seawater temperature during operation the corrosion factor is very high. JEVI recommend a coating on all surfaces which has possibility for contact with seawater.

CAUTION	The flange for the goose neck must at all-time be open, and never be covered or temporally closed.
CAUTION	If the installed WCBR is sea water a version, it should be observed that the loose weld-neck flanges in AISI 316, has to be corrosion protected by the yard, or replaced yard supplied flanges.

Cover the WCBR with a blanket or plastic if there is any steel grinding or welding near the WCBR. Not doing this will result in contamination of the stainless steel, which will lead to corrosion.

6.3 Recommended tightening torque according to thread size

Thread size	Torque (Nm)
M4	2,0
M5	3,2
M6	5
M8	10
M10	16
M12	25
M16	50

6.4 Electrical installation

	WARNING	Do not open the junction box when energized.
---	----------------	--

Follow the electrical wiring diagram

1. Connect the protective conductor to the earth bosses base of the vessel. The earth bosses are marked with green/yellow labels.

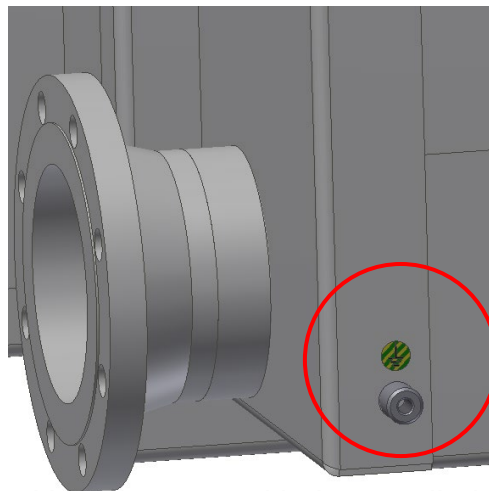

2. Open the junction boxes by unlocking the cover with the supplied door lock key.
3. Remove the protection plate inside the junction box by unscrewing the four M5 bolts.
4. Connect the main power cables and the earth cable to the copper bus bars. Follow the electrical wiring diagram. The bus bars are designed for IEC standard 1 and 2-hole cable lugs dimensions as mentioned in GA Drawing. The M12 bolts must be tightened according to table in section [6.3 Recommended tightening torque according to thread size](#)

5. Connect the instrument cables to the terminals inside the AUX junction box. Follow the electrical diagram.
6. Note that all boxes are supplied with holes suitable for the cable size mentioned in GA Drawing. The glands are only supplied if they are shown in the GA Drawing
7. Power up the anti-condensation heater in the WCBR junction box and the auxiliary junction box and check that all heaters are functional. The powers for the anti-condensation heaters must be kept on at all times until the ship/rig are in operation. If this is not possible place silica gel bags inside the boxes until the anti-condensation heaters can be turned on. Before proper installation, it shall be checked regularly that the desiccant bags are still functional.
8. *Fresh-water model with flow transmitter only:*
Remember to reset the flow transmitter when starting up.
9. Mount the protective plate inside the junction box.
10. Close the cover by using the door lock key that is supplied with the WCBR.

7.0 Start up

Remove desiccant bag from junction box before starting up.

	WARNING	Do not power up the WCBR until the below points have been completed
---	----------------	---

7.1 Start-up

Before initial start-up of the braking WCBR it shall be checked that:

1. The WCBR has been properly installed and all drains have been closed. (If any)
2. The system has been filled with cooling water.
3. Water level in the vessel is within limits as specified in the data sheet.
4. There is flow to the system. The flow can be monitored on the display located on each flow sensor (if supplied). Each WCBR should not have a flow exceeding the values given in the data sheet. A +/-5% variation in flow is acceptable. Any adjustment in the flow on non-pressurised systems shall be done on the inlet valve (If applicable).
5. The resistors must never be powered up without having a cooling water flow through the resistor. If the resistor is supplied without flow sensor, it is recommended that the yard monitors that sufficient flow is supplied.
6. The control system has been powered up (Do not power up the WCBR)
7. *Only apply for supplied instruments:* The Element monitoring systems have been actuated, e.g. TSHH, Element temperature transmitter/relay
8. Check that resistor element temperature does not exceed the max. value mentioned in the data sheet.
9. There are no leaks at gasket joints. If necessary re-tighten the bolts torques according to section [6.3 Recommended tightening torque according to thread size](#)
10. All temperature sensors are showing the same temperature within +/- 2 °C. (*This can be done by moving the display panel on the PR-4131 temp. relays if these are supplied*)
11. The electric connection has been done in accordance with the relevant regulations and the WCBR has been properly connected.

12. The protective conductor has been connected and if necessary, the external connection between housing and earth has been effected, e.g. to avoid electrostatic discharging.
13. The insulation resistance of the WCBR element is more than 3 M Ohm. Connect the Megger to an earth bolt and one of the phases. If the measured value is less than 3 M Ohm, each heating element should be checked separately. Minimum value 3 M Ohm at 1000 Volts. Read maintenance procedure if lower values are observed.

The WCBRs are now ready for load.

7.2 How to switch off the WCBR

1. De-energise the WCBR before shutting down the flow.
2. Re-tighten the bolted joints after the WCBR has cooled down.

7.3 Spare parts

Spare parts are ordered at JEVI with reference to spare part list.

8.0 Operating instructions

- Connect the cooling water system to the flanges according to the GA drawing. Inlet is always on the bottom manifold and outlet is on the top. Note that the Inlet and Outlet flanges are not designed to obtain all kinds of forces from the piping system. It is therefore recommended to use flexible joints on inlet and outlet.
- Cover the WCBR with a blanket or plastic if there is any steel grinding or welding near the WCBR. Not doing this will result in contamination of the stainless steel, which will lead to corrosion.

8.1 Operating temperature

For specific operating temperature see Data Sheet.

CAUTION	Recommended operating temperature: Sea water cooled WCBR 65°C Fresh water cooled WCBR 75°C
----------------	--

It is not necessary to make any adjustments or changes of settings during normal operation. It is, however, recommended to check/monitor the following values on a continuous basis.

1. Outlet temperature not to exceed the operational values mentioned in the data sheet at any time.
2. *Only apply if supplied with element temperature transmitter:*
Element temperature does not exceed the value mentioned in the data sheet.
3. Pressure is not to exceed the Design Pressure mentioned in the datasheet at any time.
4. Rated flow is within rated limits +/- 5%. The WCBRs must never be powered up without having a cooling water flow through the WCBR.

NOTICE	(Only apply for flow sensors on fresh water cooled WCBR) Each time the system is filled with water it is important to loosen the hose connectors at the differential flow transmitter till water is trickling out beside the connector, and then re-tighten afterwards. The differential flow transmitter is not able to give a correct read-out if the piping is not water-filled.
---------------	--

9.0 Maintenance instructions

	WARNING	Handling of the equipment must meet the requirements of DS/EN 50110-1:2013 (electrical safety).
---	----------------	---

9.1 Overview of the inside of the WCBR

The main function of the flow separator plates is to have an optimal flow around the resistor element in BRU. The flow separator plates are situated in rows, which guides the water to flow in a horizontal direction crossing the resistor elements of the WCBR five times.

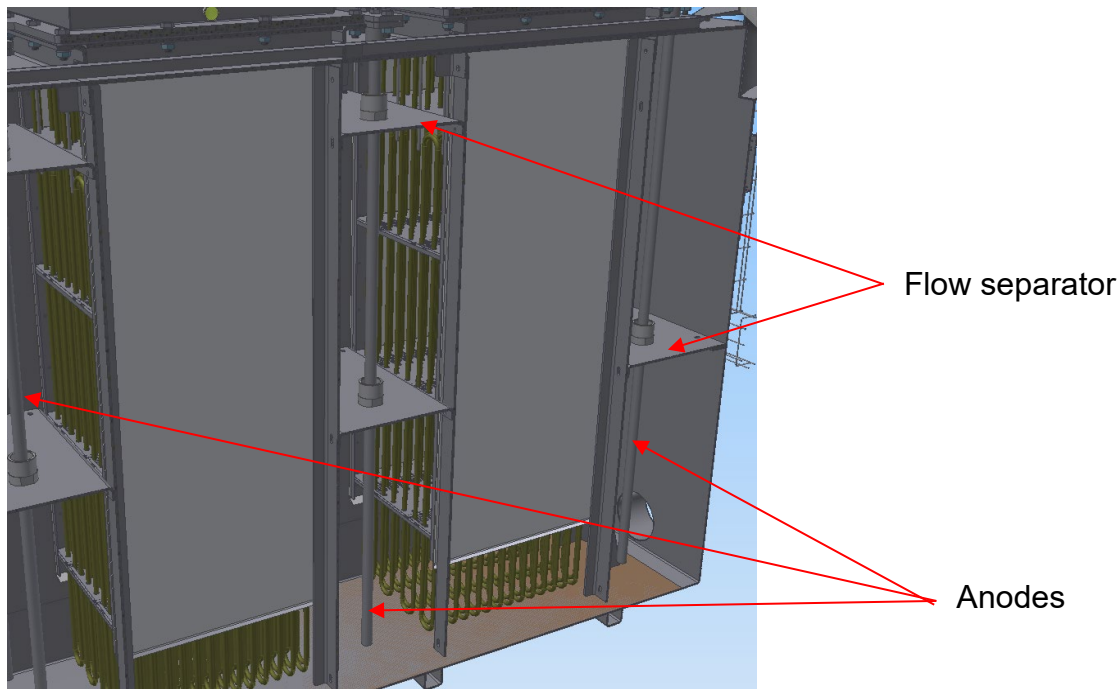

Section view of centre of vessel with 6 inserts

9.2 Cathodic protection of the vessel

The vessel is protected against corrosion in three levels. The first level of protection, FBE Coating (Fusion Bonded Epoxy Coating) is the main protection of the vessel.

The second level is the main anodes made of 99.9% pure iron (see the section view in the picture above), which is an effective anode that protects the vessel against corrosion. The anodes will by time dissolve and iron particles will be free in the vessel. This is the reason why iron particles over time will be found on the inner surface of the vessel.

The third level of corrosion protection is the flow separator plate. The plate is made in carbon steel (S 235JR) with a layer of powder coating. Since the flow separator during the mounting of the WCBR is being used as staircases, the plates have been surface

treated with powder coating to make sure that the carbon steel particles will not be spread to the outer part of the WCBR.

NOTICE	The powder coating on the separator plates will disappear shortly after initialization and will be dissolved in the cooling water.
---------------	--

The separator plates work like secondary anodes, if the main anodes are not inspected and changed according to the recommended maintenance instructions. The corrosion rate of the separator plates will be 0.1 – 0.2mm/year. The plates must be inspected every 3 years according to the recommended maintenance plan, [9.8 Recommended maintenance and service plan](#)

The design life for the plates is 10 years. However, depending on water quality and use, the lifetime can be both higher and lower.

Figure 2 shows how there is contact between the stainless-steel bolts and the carbon steel plate. The clear contact between the bolts and the plate is made, to make sure that the separator plates will work as anode preventing the bolts against corrosion. In other words, corrosion will be expected in the uncoated areas.

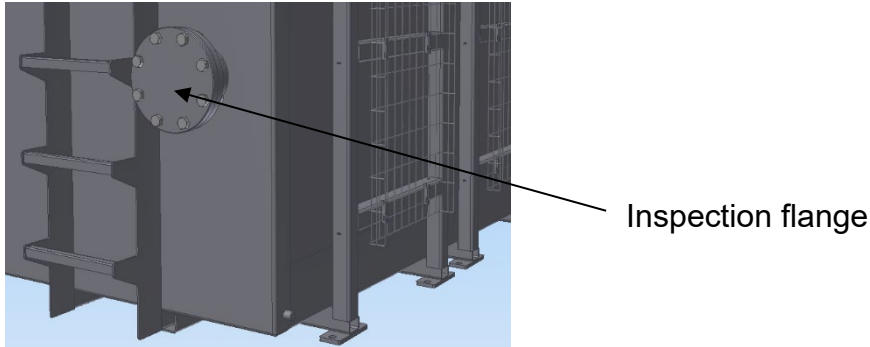

Fig. 2 The bolts on the flow separator plates.

9.3 Maintenance instructions 6-months interval

Check the following item with 6-months interval if the resistor is used in sea water.

1. Remove the inspection flange on the side of the resistor.



2. Inspect the resistor elements for marine growth and excessive scaling.
If the elements are covered with marine growth, the resistor inserts must be removed from the vessel according to section [9.7 Disassembly of WCBR insert](#), and cleaned as described below.
Clean the surface of the resistor elements using a non-metallic tool or high pressure water cleaning.



Insert with marine growth which cannot be removed by using high pressure water cleaning. This requires cleaning by using non-metallic tools to remove the dirt hanging on the heating elements.

9.4 Maintenance instructions 1-year interval

Check the following items once every year if the resistor is used in clear sea/fresh water. If used in very muddy sea water near the coast, the resistor must be cleaned with shorter intervals as there is a risk of mud build-up inside the vessel.

1. Check the insulation resistance of the element. Connect the Megger to the Earth bar and each of the phases. If the measured value is less than 3 M Ohm, each heating element should be checked separately. Minimum value is 3 M Ohm at 1000 Volts. Make sure that the safety regulations for this test are observed properly.
2. If the insulation resistance is less than 3 M Ohm, it might be caused by the anti-condensation heater not operating correctly or the gasket for the lids needs to be checked for possible leaks.

NOTICE	If the insulation resistance has changed to an unacceptable level, it is recommended to open the WCBR junction box in a dry room and let the element connections dry out by means of a hot-air blower (note: air < 80 ° C).
---------------	---

3. Check the resistance of each resistor insert and cross reference with JEVI internal Test Record for the individual resistor and resistor insert. If the value has changed more than 10% from its original value, it should be checked if any of the resistor elements have failed. Failed elements must be electrically disconnected and replaced by spare elements (marked *spare* in the wiring diagram).
4. Drain the system.
5. Remove the inspection flange on the side of the resistor.

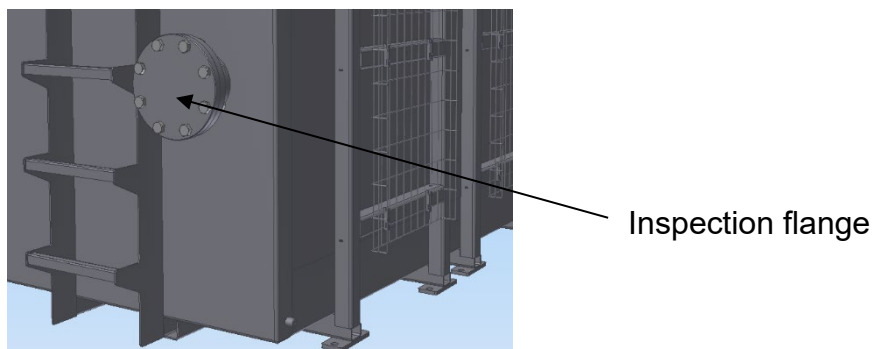

6. Inspect the resistor elements for marine growth and excessive scaling. If the elements are covered with marine growth, the resistor inserts must be removed from the vessel and cleaned as described below.

Clean the surface of the resistor elements using a piece of hard wood approx. dimension 50x15x1000 mm. Never use metal tools for the cleaning. Alternatively clean the element by using high pressure water cleaning.

7. Sea-water resistors only:
Check the bottom of the vessel for built-up of mud. Mud must never cover any of the resistor elements. If that happens there is an increased risk of damage on the resistor element due to poor cooling. Mud can be cleaned out by using a fire hose through the inspection flange or - in worse cases - by removing one of the resistor inserts for better access.
8. Only for sea-water resistor: Change the main anodes as described in section [9.6 Instruction for anode replacement \(only for seawater\)](#)
The number of anodes can be seen on the GA-Drawing.
9. Re-install the resistor inserts and tighten the bolts according to section [6.3 Recommended tightening torque according to thread size.](#)
10. Only for sea-water resistor: Remove the level sensor and clean it for any marine growth. Re-install after cleaning and tighten the bolt according to section [6.3 Recommended tightening torque according to thread size.](#)
11. Make sure that all covers for the enclosures are closed before leaving the resistor.

CAUTION	Local safety regulations shall be observed before sending persons into the main vessel.
NOTICE	Only for sea-water resistor: When the braking resistor is out of use, it must be filled with liquid for the anodes to be in contact with the liquid. If the braking resistor is not in operation for more than one week it must be emptied and rinsed with fresh water. This is to avoid sea water trapped in the bottom for the vessel without contact to the anodes.

9.5 Maintenance instructions 3-year interval

As described above (1-year interval), and with these additional points:

1. Remove all resistor inserts from the vessel.
2. Check for visual damage of the heating elements.
3. Clean the surface of the resistor elements using a piece of hard wood approx. dimension 50 x 15 x 1000 mm. Never use metal tools for cleaning. Alternatively clean the element by using high pressure water cleaning.

4. Only for sea-water resistor: Clean the vessel and inspect the coating for any defects. If any defects are found, it is required to repair the coating. Repair coating kit can be found on the spare part list.
5. Inspect all flow separator plates inside the vessel for damage and measure the thickness. If the thickness is below 4 mm the plates should be replaced. The design life for the plates is 10 years. However, depending on water quality and use, the lifetime can be both higher and lower.

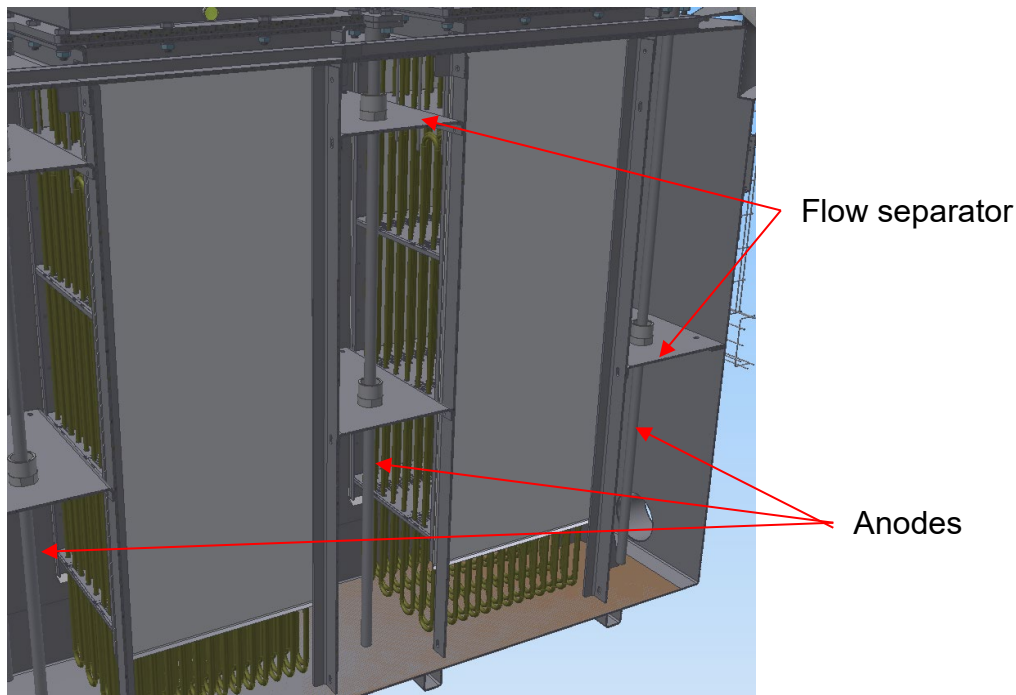

Only for sea-water resistor: Section view at centre of vessel with 6 inserts

6. Check if the flow separator plates are still securely fastened to the vessel. Retighten the bolts if necessary.

NOTICE	It is recommended to change all gaskets at the 3-year maintenance
---------------	---

9.6 Instruction for anode replacement (only for seawater)

1. Remove the two bolts and nuts on all the anodes.
2. Rotate the top plate 90° in order to get a good grip when lifting the anode out of the vessel. The weight of a new anode is less than 20 kg.
3. Install the new anode and tighten the two bolts. Spare anodes are supplied complete with new brackets.



NOTICE	Be careful not to damage the vessel coating when removing and installing the anodes
NOTICE	It is important to use original anodes from the supplier. The original anodes are made of 99.9% pure iron, which guarantee a uniform corrosion of the anodes. Normal construction steel corrodes unevenly which can result in part of the anode becoming separated from the galvanic circuit and thereby becoming ineffective.

9.7 Disassembly of WCBR insert

1. Remove the “cable extension box” (if supplied, see picture below) by unscrewing the M6 bolts located in the main junction box.
2. Dismount the main cables from the busbars.
3. Dismount all the main bolts in the flange.
4. Attach the lifting lug to the flange of the resistor. There are 3 different lifting positions on the flange to ensure that it is always possible to lift at the Centre of Gravity. The weight of the resistor insert can be found in the WCBR Data Sheet.
5. Carefully pull up the resistor. It is important to pull it up vertically.



Cable extension box

6. Place the resistor on a flat surface in horizontal position. (see picture) The resistor insert must never rest on the resistor elements.

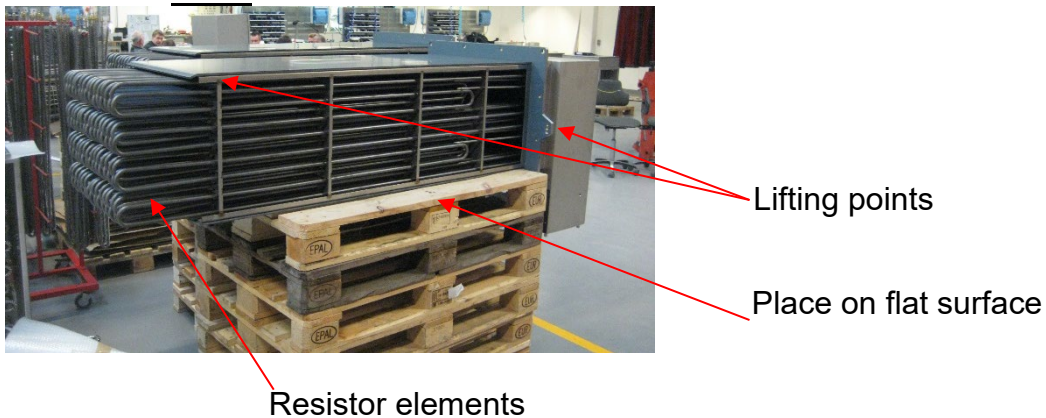

9.8 Recommended maintenance and service plan

- Check or clean
- Spare/replacements parts

System	Item	Periodic maintenance interval			
		Weekly (first 4 weeks)	Every 6 months	Every 12 months	Every 36 months
Whole	Visual inspection the exterior	○			
	Tightening all major bolts and nuts	○			
	Change silica gel in the storage period		●		
	Cleaning interior and exterior with fresh water		○		
Cooling system	Inspection/function of all valves			○	
Insert	Cleaning heating elements			○	
	Main gasket			●	
	Marine growth *			○	
	Thickness of anodes *			●	
Electrical system	Measurement of Ohm values according to test record (max deviation 10%)			○	

	Checking the wiring connections			○	
	Measurement of voltage on condense heater			○	
	Measurement of insulation resistance <3 m Ohm at 1000 VDC			○	
Vessel	Inside coating (if sea water cooled)				●

Note: *These procedures are considered normal maintenance and are performed at the owner's expense.*

* Depending on the environment, inspection frequency can vary.

10.0 Trouble shooting

Disconnect all power sources prior to any inspection, service, or cleaning. Hazard for electric shock exists while the equipment is connected.

For maintenance requiring repair or replacement of components, contact the factory immediately for further instruction. Only the failures within the scope of normal maintenance are listed below. If a problem is not listed or it is not eliminated by listed corrective measures, immediately contact JEVI A/S for assistance.

Problem	Possible cause	Possible correction
Fan not operating	No power to the motor	Loose connection at terminal block. Motor power source disconnected.
Heater/resistor failure	Loose bus bar Resistor element burned out	Tighten failed resistor bank. Disconnect element and use spare.
Temperature switch trip	Resistor over temperature	Ensure air intake and exhaust are clear of foreign particles or blockage. Check fan operation.
Pressure differential trip	Loose connections. Intake obstruction	Check all connections. Remove and clean.

11.0 Disposal instructions

Equipment containing electrical components shall not be disposed together with domestic waste. Collect separately with other electrical and electronic waste, according to local legislation.

JEVI A/S
Godthåbsvej 7
DK-7100 Vejle
T: +45 75 83 02 11
jevi@jevi.dk
www.jevi.com